

COMPAL CONFIDENTIAL

MODEL NAME: *NAVE0*
 PCB NAME: *LS-6097P PWR/B*
 COMPAL P/N: *DA40000RS10*
 REVISION: *1.0*
 DATE: *2010/02/10*

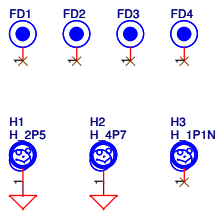

06/26 Update hole
 07/08 Update hole
 08/06 Update hole

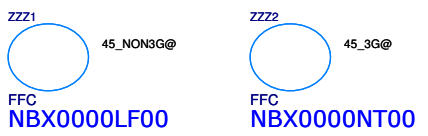
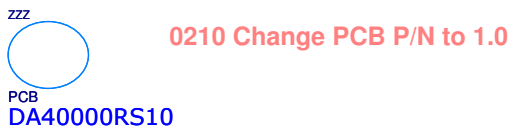
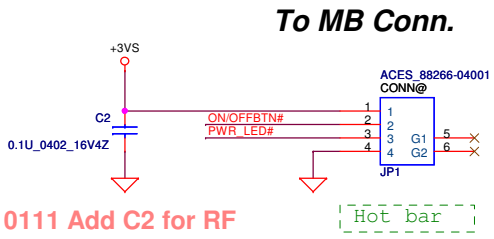

0111 Add C2 for RF

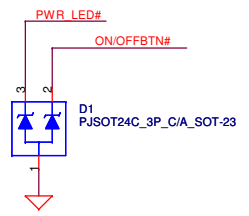

07/06 Update D1

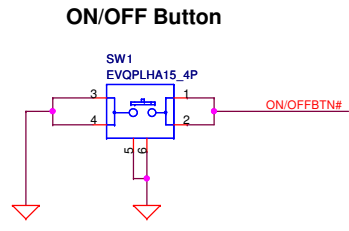

06/26 Update SW1

ON/OFF LED LEFT

09/03 Update power to +3VS

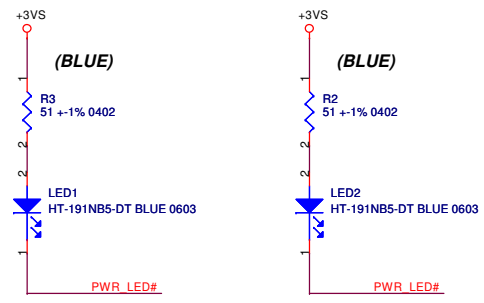

10mil 10mil

06/26 Update LED1 、 LED2
 10/07 Update R3, R2 to 51 +-5% 0402

FOR EMI

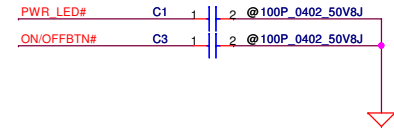

Security Classification		Compal Secret Data		Compal Electronics, Inc.	
Issued Date	2008/09/17	Deciphered Date	2009/09/17	Title PWR/B	
THIS SHEET OF ENGINEERING DRAWING IS THE PROPRIETARY PROPERTY OF COMPAL ELECTRONICS, INC. AND CONTAINS CONFIDENTIAL AND TRADE SECRET INFORMATION. THIS SHEET MAY NOT BE TRANSFERRED FROM THE CUSTODY OF THE COMPETENT DIVISION OF R&D DEPARTMENT EXCEPT AS AUTHORIZED BY COMPAL ELECTRONICS, INC. NEITHER THIS SHEET NOR THE INFORMATION IT CONTAINS MAY BE USED BY OR DISCLOSED TO ANY THIRD PARTY WITHOUT PRIOR WRITTEN CONSENT OF COMPAL ELECTRONICS, INC.				Size Custom	Document Number NAVE0 LS-6097P
				Date: Wednesday, February 10, 2010	Rev 0.1
				Sheet 1 of 1	